

In Car Video

IVMS-5802 IVMS-6502

Operating and installation instructions



 **BLAUPUNKT**

DEVICE OVERVIEW

Device overview

5.8" and 6.5" TFT-LCD screen

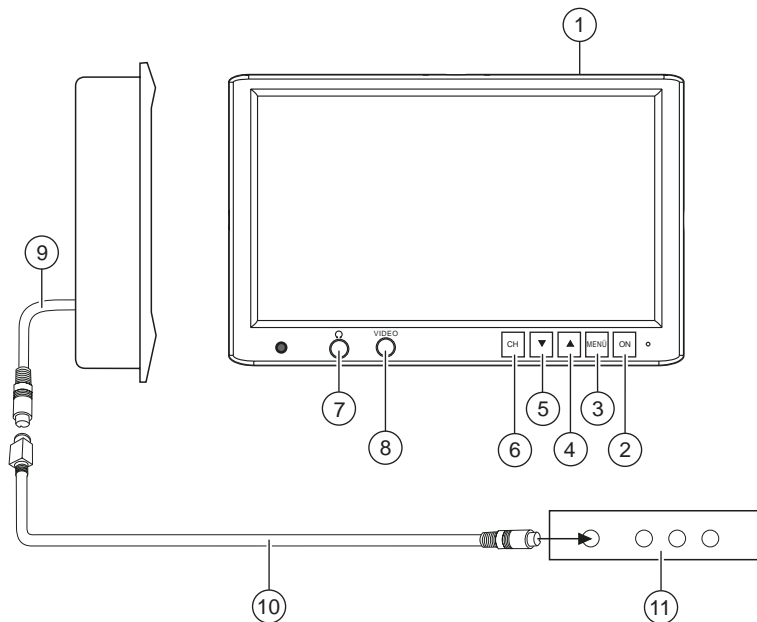

- ① 5.8"/6.5" TFT LCD screen for headrests
- ② On/off switch
- ③ Key for screen menu display (OSD menu)
- ④ Up menu
- ⑤ Down menu
- ⑥ AV channel setting (AV1 - AV2 - ...)

- ⑦ Headphone socket
- ⑧ Video input (internal)
- ⑨ Connecting cable
- ⑩ Interface cable
- ⑪ AV signal converter unit

Device overview	14	Removal	21
5.8" and 6.5" TFT-LCD screen	14	OSD menu	22
General information	16	Operation	22
Important notes	16	IR remote control	23
Safety notices	16	Functions	23
Accessories	17	Specifications	24
Accessories supplied	17	5.8" screen	24
Available accessories	17	6.5" screen	25
Fitting	17	Connection diagram	109
Monitor installation	17		
Prepare the working area	17		
Mark out the dimensions	17		
Carefully cut open the headrest cover	18		
Open the headrest and remove filling and other items	18		
Lay the cable through the headrest .	19		
Insert the mounting frame in the headrest	19		
Inserting the monitor	19		
Check and adjust the monitor then apply the Velcro strips	20		
Example of a direct connection to a DVD player	20		
Positive connection	20		
Negative (ground) connection	21		

NOTES

General information

Thank you for choosing a Blaupunkt product. We hope you enjoy using this new piece of equipment.

Please read these operating instructions before using the equipment for the first time.

The Blaupunkt editors are constantly working on making the operating instructions clearer and easier to understand. However, if you still have any questions on how to operate the device, please contact your dealer or the telephone hotline for your country. You will find the telephone number printed at the back of this booklet.

We provide a manufacturer guarantee for our products bought within the European Union. You can view the guarantee conditions at www.blaupunkt.de or ask for them directly at:

Blaupunkt GmbH
Hotline
Robert Bosch Str. 200
D-31139 Hildesheim

Important notes

This device is not intended for fitting in the forward section of the passenger compartment where it could also be seen by the driver. Fitting this device in any part of the vehicle where it could interfere with or distract the driver's attention is dangerous and is not permitted. The manufacturer cannot accept responsibility for any damage caused as a result of improper fitting of this device.

 To avoid the risk of electrical shock, the device must be protected from water and moisture, and must not be opened. Dangerously high voltages are generated inside the device.

We wish to point out that the right to claim against warranty is invalidated by any changes or modifications to the device that have not been explicitly approved by the manufacturer.

Long-term operation or storage outside the specific temperature range can lead to a shortening of the useful life of the LC display.

Safety notices

Please observe the following safety notices during installation and whilst making the connections.

- Disconnect the negative and positive terminals of the battery.
- When doing so, please observe the safety notices provided by the vehicle manufacturer.
- Before drilling the holes necessary for mounting the equipment and for laying cables, please make sure that concealed cables, the fuel tank and fuel lines cannot be damaged in the process!

Accessories

Accessories supplied

- Connecting cable
- Extraction tool
- Operating instructions
- Mounting plate
- Adapter cable for a direct connection to an AV source
- IR remote control IVRC-06

Available accessories

- Monitor bracket 7608009300

The installation instructions are included with the bracket.

Note regarding VIDEO IN/AUX:

Only use original Blaupunkt accessory 7 607 001 510.

Or else use a mono plug.

Fitting

Monitor installation

Note:

It is recommended that the fitting is carried out at a specialist workshop.

Prepare the working area

- ⇒ Remove the headrest, and place it on a working surface that has been cleared and cleaned, where the further assembly procedures may be carried out.

Note:

Take appropriate action to ensure that the headrest is not damaged while fitting the monitor.

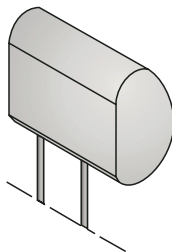

Mark out the dimensions

- ⇒ Feel the covering of the headrest carefully to ensure that there are no invisible parts that would prevent the monitor from being fitted.

Mark out the surface that needs to be cut out - its size must match that of the installation frame.

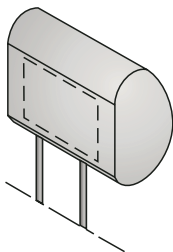

Carefully cut open the headrest cover

Use a knife with an adjustable cutting depth to cut out the planned area.

- ⇒ Make the first cut inside the marked area at a point about 0.5 cm from one of the corners, then make a diagonal cut to a point about 0.5 cm from the opposite corner.
- ⇒ Make a similar cut between the other two diagonally opposed corners.

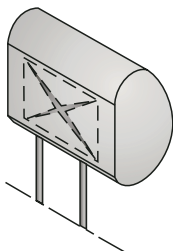

Open the headrest and remove filling and other items

- ⇒ Carefully lift the covering material away from the cut area.
- ⇒ Adjust the cutting depth of the knife to about 2.5 cm, and cut into the headrest following a line about 0.5 cm inside the marked edge.
- ⇒ Carefully lift the filling material at one corner, and cut deeper into the material with the knife.
- ⇒ Remove the filling material in small pieces.
- ⇒ As you do this, lift one piece of the filling material, and ensure that the cut is being made to an even depth.

To remove other pieces, use a Dremel saw or another suitable tool.

- ⇒ Insert the monitor to check that it will fit into the cut area, and make adjustments if necessary.

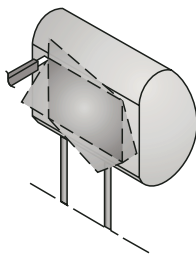

Lay the cable through the headrest

- ⇒ Now pass the supplied cables through the opening so that they emerge from the underneath of the headrest.
- ⇒ If possible, cover the cable with a cable tunnel.
- ⇒ Now connect the power supply, ground and video signal cables, to check that the monitor is working.

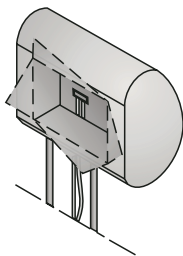

Insert the mounting frame in the headrest

- ⇒ Before connecting the monitor, pass the connecting cables through the holes provided in the mounting plate, as shown in the illustration.
- ⇒ Insert the mounting plate into the area that has been cut out, and fix it in place with appropriate fastenings.

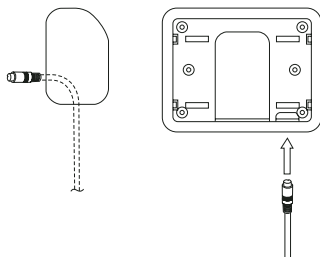

Inserting the monitor

- ⇒ Before connecting the monitor, pass the connecting cables through the holes provided in the mounting plate, as shown in the illustration.
- ⇒ Insert the monitor into the mounting plate, and attach it with appropriate fastenings.

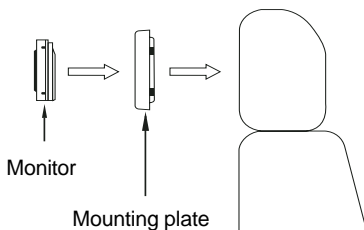

FITTING

Check and adjust the monitor then apply the Velcro strips

- ⇒ Connect the monitor, place it temporarily in the cut-out, and place the headrest into position.
- ⇒ Check the various monitor settings such as brightness, headphone function, volume control and so on.
- ⇒ Then attach the Velcro strips to the rear of the monitor, and push the frame onto the headrest.

Take care not to press the screen itself, and apply pressure only in the region of the frame.

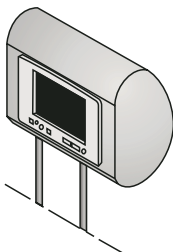

Example of a direct connection to a DVD player

Adapter cable for a direct connection to an AV source

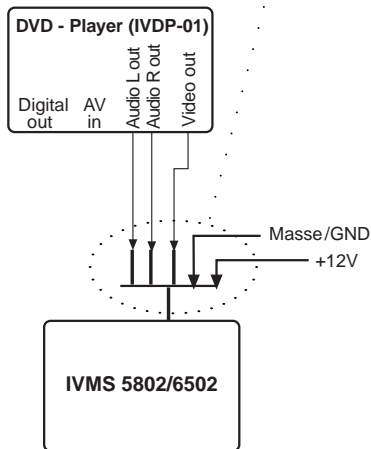

Positive connection

Connect the fuse holder to protect the positive cable (+12 V). The fuse holder should be connected to the positive terminal at a distance of max. 30 cm from the vehicle battery (if necessary, drill a hole in the bulkhead and use the appropriate cable grommets).

Negative (ground) connection

Attach the negative cable (earth/GND) directly to the vehicle body using a screw. Scratch the surface down to the bare metal at the point at which the ground is made.

- If the installation requires holes to be drilled or any other changes to be made to the vehicle, please contact a specialist workshop in your area.

Removal

- ⇒ To remove the screen, insert the extraction tool between the screen and the mounting plate.
- ⇒ Insert the extraction tool at the place where a slot has been provided between the screen and the mounting plate.

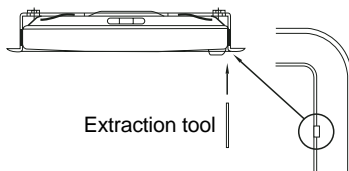

OSD MENU

OSD menu

Operation

- ⇒ Press the "MENU" button on the display or on the remote control to open the OSD menu.
- Use the arrow buttons **▲/▼** to select the options and after you press the MENU button you can use the arrow buttons **◀/▶** to change the settings.
- ⇒ Press the "EXIT" option to close the OSD menu again.

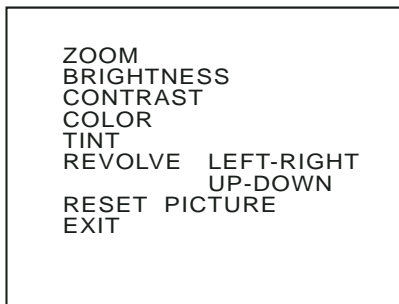

- ZOOM (picture size):
Change the picture height/width
 - FULL
 - NORMAL
 - WIDE
- BRIGHTNESS
To adjust the brightness
- CONTRAST:
To adjust the contrast
- COLOR:
To adjust the colour

- TINT:
To adjust the picture shade (only for NTSC)
- REVOLVE:
To revolve the screen display
 - LEFT - RIGHT
Horizontally mirrored
 - UP - DOWN
Vertically mirrored
- RESET PICTURE:
To reset the configured parameters to the factory default settings.
- EXIT:
To close the OSD menu

IR remote control

Functions

The supplied remote control is suitable for operating the following monitors: IVMS-5802 and IVMS-6502.

- ① **POWER**
On/off button for the monitor.
- ② **TV/VIDEO**
No function.
- ③ **VOL • arrow button** ▲
Increase the volume for the selected monitor.
VOL • arrow button ▼
Decrease the volume for the selected monitor.
- ④ **MUTE**
Mute the volume of the loudspeakers inside the monitor.
- ⑤ **CH • arrow button** ▲/▼
Channel selection if the monitor is connected to a signal controller IVSC-3302 or IVSC-5502.

Caution:

The way the **CH** ▲/▼ buttons function depends on the monitor selection (which is made using the signal controller's remote control).

- ⑥ **Menu**
See OSD menu, operation (page 22).

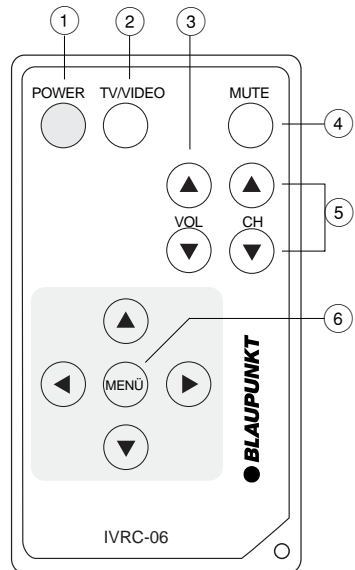

SPECIFICATIONS

Specifications

5.8" screen

System:	NTSC/PAL auto switch
Power supply / consumption:	12 V direct current, $\pm 10\%$, <900 mA
Standby:	< 1 mA
Video input level:	1 V _{pp} , 75 ohms
Audio input level:	0 - 0.3 V _{rms} , 20 Hz - 20 kHz
Operating temperature:	-20° C to +60° C
Storage temperature:	-30° C to +80° C
Screen size (diagonal):	5.8" (14.7 cm)
Contrast ratio:	60
Power consumption:	< 11 W
Brightness:	300 cd/m ²
Display technology:	TFT active matrix system
Resolution (pixels):	1200 (H) x 234 (W) = 280,800 pixels
Visible screen area:	127.20 (W) x 71.84 (H) mm
Viewing angle:	From the left and right: 60°, From above: 60°, From below: 30°
Total monitor dimensions:	165 (W) x 122 (H) x 26.7 (D) mm
Monitor weight:	< 400 g

6.5" screen

System:	NTSC/PAL auto switch
Power supply / consumption:	12 V direct current, $\pm 10\%$, <900 mA
Standby:	< 1 mA
Video input level:	1 Vpp, 75 ohms
Audio input level:	0 - 0.3 Vrms, 20 Hz - 20 kHz
Operating temperature:	-20° C to +60° C
Storage temperature:	-30° C to +80° C
Screen size (diagonal):	6.5" (16.5 cm)
Contrast ratio:	60
Power consumption:	< 10 W
Brightness:	280 cd/m ²
Display technology:	TFT active matrix system
Resolution (pixels):	1200 (H) x 234 (W) = 280,800 pixels
Visible screen area:	142.80 (W) x 87.70 (H) mm
Viewing angle:	From the left and right: 60°, From above: 60°, From below: 30°
Total monitor dimensions:	176.0 (W) x 122 (H) x 26.7 (D) mm
Monitor weight:	< 400 g

Subject to changes!

Beispielanschluss mit verschiedenen Komponenten /
 Connection example with various components

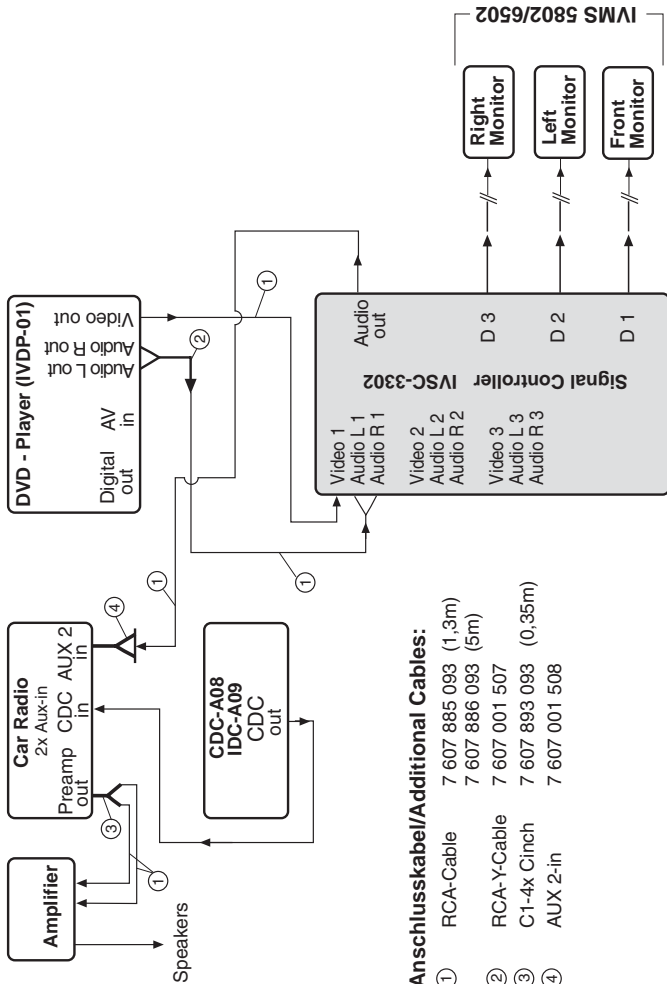

Anschlusskabel/Additional Cables:

- ① RCA-Cable 7 607 885 093 (1,3m)
7 607 886 093 (5m)
- ② RCA-Y-Cable 7 607 001 507
- ③ C1-4x Cinch 7 607 893 093 (0,35m)
- ④ AUX 2-in 7 607 001 508

Service-Nummern / Service numbers / Numéros du service après-vente / Numeri del servizio di assistenza / Servicenummers / Telefonnummer für service / Números de servicio / Número de serviço / Servicenumre

Country:	Phone:	Fax:	WWW:
Germany	(D) 0180-5000225	05121-49 4002	http://www.blaupunkt.com
Austria	(A) 01-610 390	01-610 393 91	
Belgium	(B) 02-525 5454	02-525 5263	
Denmark	(DK) 44 898 360	44-898 644	
Finland	(FIN) 09-435 991	09-435 99236	
France	(F) 01-4010 7007	01-4010 7320	
Great Britain	(GB) 01-89583 8880	01-89583 8394	
Greece	(GR) 210 57 85 350	210 57 69 473	
Ireland	(IRL) 01-4149400	01-4598830	
Italy	(I) 02-369 6331	02-369 6464	
Luxembourg	(L) 40 4078	40 2085	
Netherlands	(NL) 023-565 6348	023-565 6331	
Norway	(N) 66-817 000	66-817 157	
Portugal	(P) 01-2185 00144	01-2185 11111	
Spain	(E) 902-120234	916-467952	
Sweden	(S) 08-7501500	08-7501810	
Switzerland	(CH) 01-8471644	01-8471650	
Czech. Rep.	(CZ) 02-6130 0441	02-6130 0514	
Hungary	(H) 01-333 9575	01-324 8756	
Poland	(PL) 0800-118922	022-8771260	
Turkey	(TR) 0212-3350677	0212-3460040	
USA	(USA) 800-2662528	708-6817188	
Brasil (Mercosur)	(BR) +55-19 3745 2769	+55-19 3745 2773	
Malaysia (Asia Pacific)	(MAL) +604-6382 474	+604-6413 640	

Blaupunkt GmbH

